

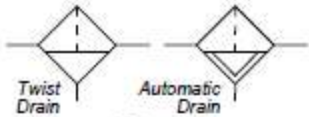

**WEST MICHIGAN RUBBER & SUPPLY**  
**1.800.533.9677**  
**sales@westmichiganrubber.com**

## FILTER



### Features

- Excellent water removal efficiency.
- Unique deflector plate and shroud creates a swirling of the air stream ensuring maximum water and dirt separation.
- Large filter element surface guarantees low pressure drop and increased element life.
- Optional Push 'N' Drain requires only fingertip touch to drain. Optional automatic float drain available.
- Shown with recommended metal bowl guard.
- High Flow: 1/4" – 53 SCFM<sup>§</sup>  
 3/8" – 80 SCFM<sup>§</sup>  
 1/2" – 85 SCFM<sup>§</sup>

Port Size	NPT	
	Twist Drain	Automatic Float Drain
Poly Bowl <sup>‡</sup> / Metal Guard		
1/4"	<b>06F12A*</b>	<b>06F16A*</b>
3/8"	<b>06F22A*</b>	<b>06F26A*</b>
1/2"	<b>06F32A*</b>	<b>06F36A*</b>
Metal Bowl / Sight Gauge		
1/4"	<b>06F14A*</b>	<b>06F18A*</b>
3/8"	<b>06F24A*</b>	<b>06F28A*</b>
1/2"	<b>06F34A*</b>	<b>06F38A*</b>

Standard part numbers shown bold.

For other models refer to ordering information below.

<sup>‡</sup> For polycarbonate bowl see Caution on page A2.

<sup>§</sup> SCFM = Standard cubic feet per minute at 90 PSIG inlet and 5 PSIG pressure drop.

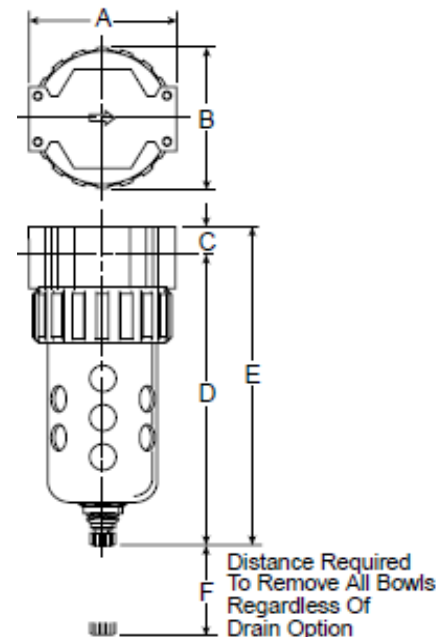

06F Filter Dimensions		
A	B	C
2.81 (71)	2.74 (70)	.53 (13)
D	D†	E
5.69 (145)	5.74 (146)	6.22 (158)
E†	F	
6.27 (159)	2.25 (57)	

Inches (mm)

† With Automatic Float Drain

# FILTER – Page 2

## Ordering Information

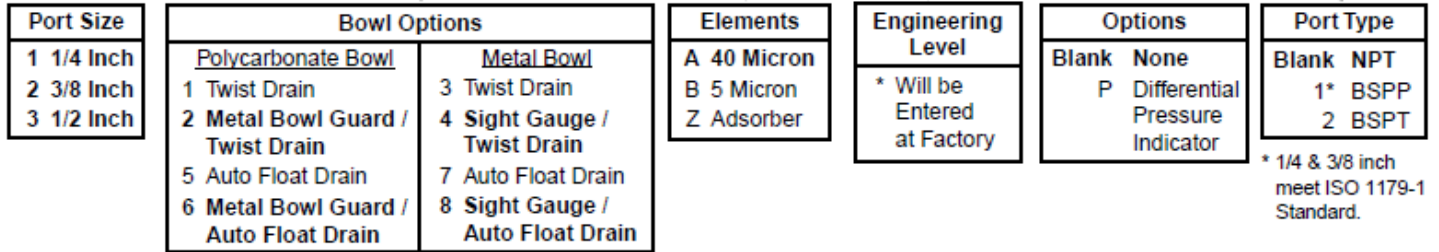
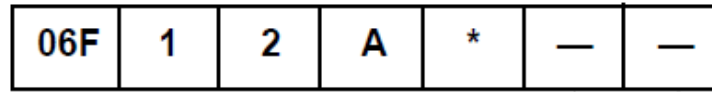

## Technical Information

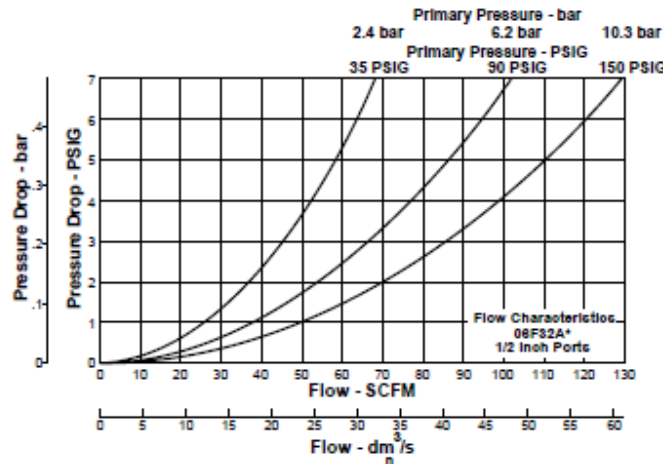
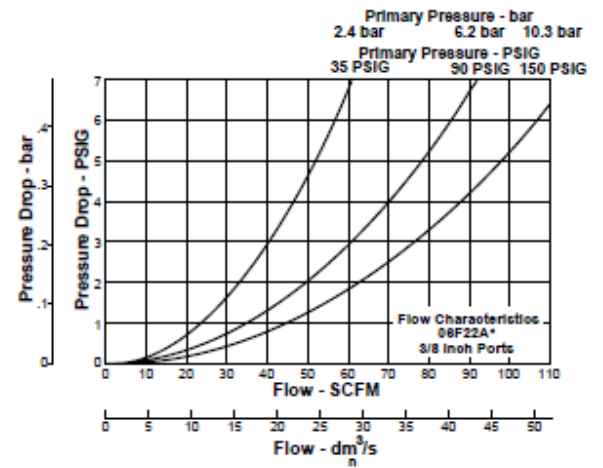
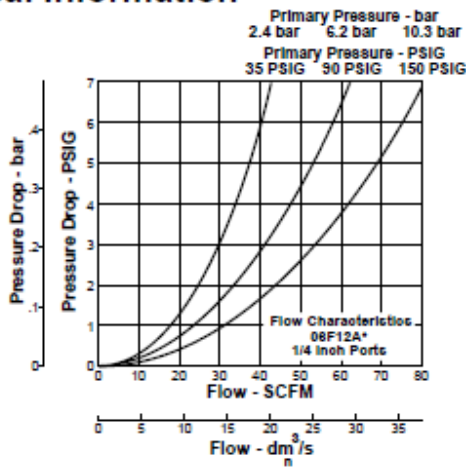

# Filter – Page 3

## 06F Filter Kits & Accessories

Bowl Guard Kit .....	PS705P
Bowl Kits –	
Poly Bowl –	
Automatic Float Drain .....	PS722P
Twist Drain .....	PS732P
Metal Bowl –	
Automatic Float Drain .....	PS726P
Twist Drain .....	PS734P
Sight Gauge / Automatic Float Drain .....	PS723P
Sight Gauge / Twist Drain .....	PS735P
DPI Replacement Kit .....	PS781P
Drain Kits –	
Automatic Float Drain .....	PS506P
Semi-Auto Drain .....	PS511P
Twist Drain .....	PS512P
Push 'N' Drain .....	PS513P
Filter Element Kits –	
40 Micron .....	PS701P
5 Micron .....	PS702P
Adsorber .....	PS731P
Mounting Bracket Kit .....	PS743P
Sight Gauge Kit .....	PS914P

## Specifications

Bowl Capacity .....	4.4 Ounces
Sump Capacity .....	1.75 Ounces
Port Threads .....	1/4, 3/8, 1/2 Inch

## Pressure & Temperature Ratings –

Without Differential Pressure Indicator:

Polycarbonate Bowl – 0 to 150 PSIG (0 to 10.3 bar)  
32°F to 125°F (0°C to 52°C)

Metal Bowl – 0 to 250 PSIG (0 to 17.2 bar)  
32°F to 175°F (0°C to 80°C)

With Differential Pressure Indicator: 0 to 150 PSIG (0 to 10.3 bar)  
32°F to 125°F (0°C to 52°C)

Automatic Float Drain – 15 to 250 PSIG (1.0 to 17.2 bar)

Weight.....1.4 lb. (0.6 kg)

## Materials of Construction

Body .....	Zinc
Bowls .....	Transparent Polycarbonate or Metal (Zinc) With or Without Sight Gauge
Bowl Guards .....	Steel
Collar .....	Plastic
Deflector, Shroud & Baffle .....	Plastic
Drains –	
Twist Drain – Body & Nut .....	Plastic
Push 'N' Drain –	
Body .....	Nitrile
Stem .....	Brass
Automatic Float Drain – Housing, Float .....	Plastic
Seals .....	Nitrile
Springs, Push Rod .....	Stainless Steel
Filter Elements –	
40 Micron (Standard) .....	Plastic
5 Micron (Optional) .....	Plastic
Adsorber (Optional) .....	Activated Charcoal
Seals .....	Nitrile
Sight Gauge .....	Polyamide