













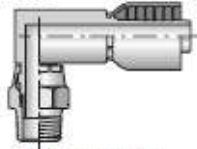







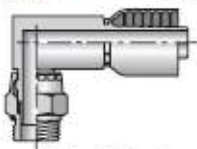













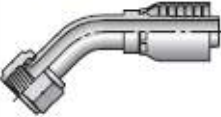
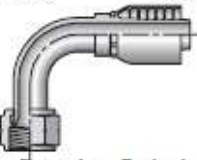

WEST MICHIGAN RUBBER & SUPPLY









1.800.533.9677







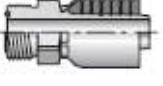

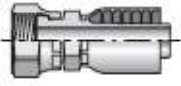
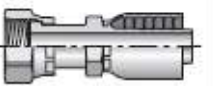















sales@westmichiganrubber.com

43 SERIES HYDRAULIC HOSE ENDS











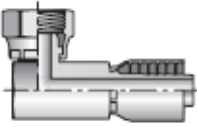

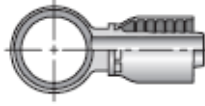

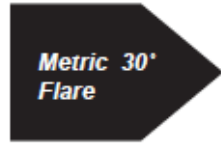
 <p>NPTF Pipe</p>	<p>10143 B-29</p>  <p><i>Male - Rigid</i></p>	<p>11343 B-29</p>  <p><i>Male - Swivel</i></p>	<p>11L43 B-30</p>  <p><i>Male - Swivel 90° Elbow</i></p>	<p>10243 B-30</p>  <p><i>Female - Rigid</i></p>	<p>1S243 B-31</p>  <p><i>Female - Swivel</i></p>
 <p>NPSM Pipe</p>	<p>10743 B-30</p>  <p><i>Female - Swivel</i></p>	 <p>Straight Thread O-Ring</p>	<p>10543 B-31</p>  <p><i>Male - Rigid</i></p>	<p>10G43 B-31</p>  <p><i>Male - Swivel</i></p>	<p>10L43 B-32</p>  <p><i>Male - Swivel 90° Elbow</i></p>
 <p>JIC 37°</p>	<p>10343 B-32</p>  <p><i>Male - Rigid</i></p>	<p>1LB43 B-33</p>  <p><i>Male - Bulkhead</i></p>	<p>10643 B-33</p>  <p><i>Female - Swivel</i></p>	<p>13743 B-34</p>  <p><i>Female - Swivel 45° Elbow - Short</i></p>	<p>1L743 B-34</p>  <p><i>Female - Swivel 45° Elbow - Medium</i></p>
<p>13943 B-35</p>  <p><i>Female - Swivel 90° Elbow - Short</i></p>	<p>1L943 B-35</p>  <p><i>Female - Swivel 90° Elbow - Medium</i></p>	<p>14143 B-36</p>  <p><i>Female - Swivel 90° Elbow - Long</i></p>	<p>14V43 B-36</p>  <p><i>Female - Swivel 150° Elbow</i></p>	 <p>SAE 45°</p>	<p>10443 B-36</p>  <p><i>Male - Rigid</i></p>
<p>10843 B-36</p>  <p><i>Female - Swivel</i></p>	<p>17743 B-37</p>  <p><i>Female - Swivel 45° Elbow</i></p>	<p>17943 B-37</p>  <p><i>Female - Swivel 90° Elbow</i></p>	 <p>Flareless</p>	<p>11143 B-37</p>  <p><i>Male - Rigid</i></p>	<p>11243 B-38</p>  <p><i>Female - Swivel</i></p>
<p>1GJ43 B-38</p>  <p><i>Female - Rigid</i></p>	 <p>Inverted Flare</p>	<p>12843 B-38</p>  <p><i>Male - Swivel</i></p>	<p>16743 B-39</p>  <p><i>Male - Swivel 45° Elbow</i></p>	<p>16943 B-39</p>  <p><i>Male - Swivel 90° Elbow</i></p>	 <p>Code 61 Flange</p>

43 SERIES HYDRAULIC HOSE ENDS – PAGE 2

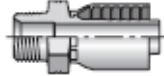
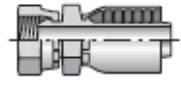
11543 B-39  <i>Flange Head</i>	11643 B-40  <i>22-1/2° Elbow</i>	12643 B-40  <i>30° Elbow</i>	11743 B-40  <i>45° Elbow</i>	12743 B-41  <i>60° Elbow</i>	11843 B-41  <i>67-1/2° Elbow</i>
11943 B-41  <i>90° Elbow</i>	Seal-Lok® (O-Ring Face Seal)	1J043 B-42  <i>Male - Rigid w/O-Ring</i>	1JB43 B-42  <i>Male - Bulkhead w/O-Ring</i>	1JC43 B-43  <i>Female - Swivel Short</i>	1JS43 B-44  <i>Female - Swivel Long</i>

1J643 B-44  <i>Female - Swivel 22-1/2° Elbow</i>	1J743 B-45  <i>Female - Swivel 45° Elbow</i>	1J943 B-46  <i>Female - Swivel 90° Elbow - Short</i>	1J543 B-46  <i>Female - Swivel 90° Elbow - Medium</i>	1J143 B-47  <i>Female - Swivel 90° Elbow - Long</i>	DIN "L" Series
1D043 B-47  <i>Male - Rigid</i>	11D43 B-47  <i>Male Standpipe Rigid</i>	1C343 B-48  <i>Female - Swivel</i>	1C443 B-48  <i>Female - Swivel 45° Elbow</i>	1C543 B-48  <i>Female - Swivel 90° Elbow</i>	DIN "L" Series w/O-Ring
1CA43 B-49  <i>Female - Swivel</i>	1CE43 B-49  <i>Female - Swivel 45° Elbow</i>	1CF43 B-49  <i>Female - Swivel 90° Elbow</i>	DIN "S" Series	1D243 B-50  <i>Male - Rigid</i>	13D43 B-50  <i>Male Standpipe Rigid</i>
1C643 B-50  <i>Female - Swivel</i>	DIN 60° Cone	1C043 B-51  <i>Female - Swivel</i>	DIN "S" Series w/O-Ring	1C943 B-51  <i>Female - Swivel</i>	10C43 B-51  <i>Female - Swivel 45° Elbow</i>
11C43 B-52  <i>Female - Swivel 90° Elbow</i>	BSP	1D943 B-52  <i>Male - Rigid</i>	19243 B-52  <i>Female - Swivel</i>	1B143 B-53  <i>Female - Swivel 45° Elbow</i>	1B243 B-53  <i>Female - Swivel 90° Elbow</i>

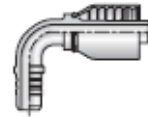
43 SERIES HYDRAULIC HOSE ENDS – PAGE 3

<p>1B443 B-53</p>  <p><i>Female - Swivel 90° Elbow - Block Type</i></p>	<p>1B543 B-54</p>  <p><i>Female - Swivel Flat Seat</i></p>	 <p>Banjo</p>	<p>14943 B-54</p>  <p><i>Metric Banjo</i></p>	<p>AM B-54</p>  <p><i>Bolt</i></p>	 <p>Metric 30° Flare</p>
<p>1MU43 B-55</p>  <p><i>Female - Swivel</i></p>	<p>1XU43 B-55</p>  <p><i>Female - Swivel</i></p>	 <p>BSP</p>	<p>1FU43 B-56</p>  <p><i>Female - Swivel</i></p>	<p>1UT43 B-56</p>  <p><i>Male - Rigid</i></p>	<p>1GU43 B-56</p>  <p><i>Female - Swivel</i></p>
 <p>French Gaz</p>	<p>1F443 B-56</p>  <p><i>Female - Swivel</i></p>	 <p>UPTC</p>	<p>1EN43 B-58</p>  <p><i>Male</i></p>	<p>1ET43 B-58</p>  <p><i>Male 90° Elbow</i></p>	<p>1EU43 B-58</p>  <p><i>Male 45° Elbow</i></p>